

**ERSATZTEILLISTE • SPARE PARTS LIST • LISTE DE PIÈCES DE RECHANGE  
LISTINO PEZZI DI RICAMBIO • LISTA DE PIEZAS DE RECAMBIO**

## **○ 5.10**

**DREHSCHIEBERPUMPEN • ROTARY VANE PUMPS • POMPES À PAQUETTES  
POMPE A PALETTE • BOMBAS DE PALETAS**

---

**MAKE IT BECKER**

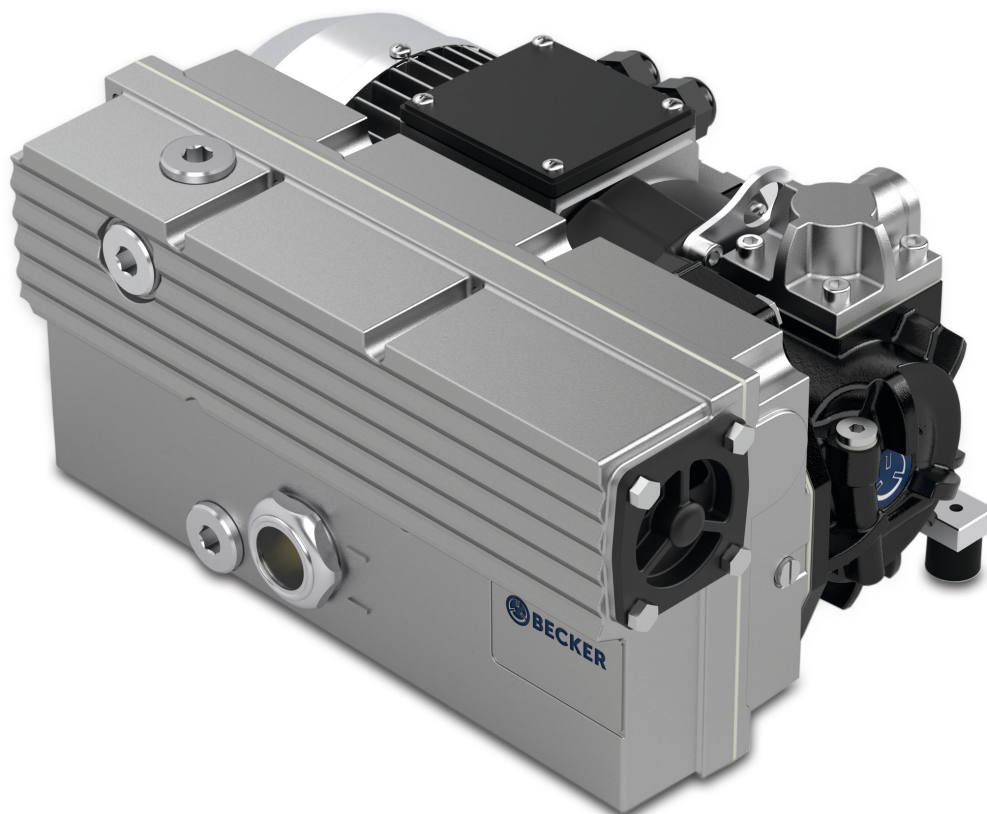

INDEX

## INDEX/INDICE

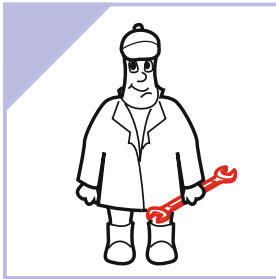

**BECKER**  
D-42279 Wuppertal  
www.becker-international.com

year

No.

CE type

frequency	<input type="text" value="XXXX"/>	Hz
speed	<input type="text" value="XXXX"/>	min <sup>-1</sup>
power required	<input type="text" value="XXXX"/>	kW
inlet capacity	<input type="text" value="XXXX"/>	m <sup>3</sup> /h
pressure +	<input type="text" value="XXXX"/>	mbar
vacuum -	<input type="text" value="XXXX"/>	mbar

Made in Germany

INDEX

[WWW.BECKER-INTERNATIONAL-SHOP.COM](http://WWW.BECKER-INTERNATIONAL-SHOP.COM)

**wichtige Komponenten - Serviceteile**  
**important components - Service Parts**  
**composants importants - Pièces de service**  
**importanti componenti - Parti di servizio**  
**componentes importantes - Partes de servicio**





INDEX	Pos.	Ident No.	Description	Quantity
	K1	549000 54600	COMPLETE SET OF SEALS	KIT
	K2	555300 55500	OIL SIGHT GLASS KIT	KIT
	K3	955300 55500	SCREW KIT	KIT
	K4	555300 55600	SIEVE KIT	KIT
	K5	555300 55700	SUCTION VALVE KIT	KIT
	K6	555300 55800	FLOAT VALVE KIT	KIT
		960017 00025	BECKER LUBE M 32 (MINERAL OIL)	0,25 l
		960003 20025	BECKER LUBE S 32 (SYNTHETIC OIL)	0,25 l
		960018 00025	BECKER LUBE SL 32 (FOOD SECTOR)	0,25 l
		960023 00300	BECKER LUBE M 68 (MINERAL OIL)	1 l
		960023 00400	BECKER LUBE M 68 (MINERAL OIL)	5 l
		960023 00500	BECKER LUBE S 68 (SYNTHETIC OIL)	1 l
		960023 00600	BECKER LUBE S 68 (SYNTHETIC OIL)	5 l
		960023 00700	BECKER LUBE SL 68 (FOOD SECTOR)	1 l
		960023 00800	BECKER LUBE SL 68 (FOOD SECTOR)	5 l

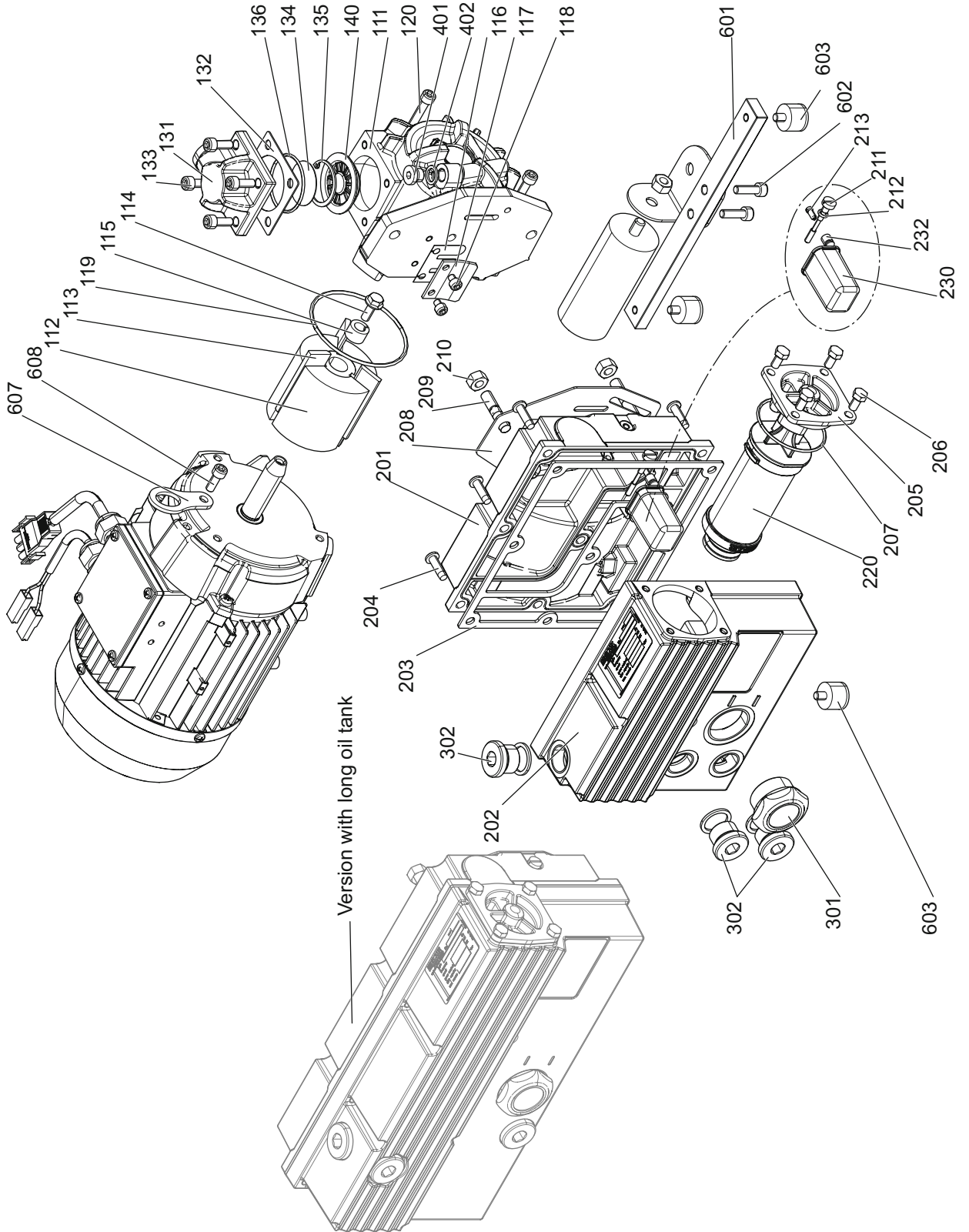

0 5.10



INDEX	Pos.	Bestell Nr.	Beschreibung	
	K1	549000 54600	DICHTUNGSSATZ	1)
	K2	555300 55500	ÖLSCHAUGLASSATZ	2)
	K3	955300 55500	SCHRAUBENSATZ	3)
	K4	555300 55600	SIEBSATZ	4)
	K5	555300 55700	SAUGVENTILSATZ	5)
	K6	555300 55800	SCHWIMMERVERTILSATZ	6)
	111	000110 64100	GEHÄUSE	
	112	020000 64200	KOLBEN	
	113	900591 00003	SCHIEBERSATZ	
	114	K3	SECHSKANTSCHRAUBE M6X16	
	115	016700 64300	SPANNBUCHSE	
	116	033910 64300	VENTILPLATTE	
	117	029110 64300	VENTILFÄNGER	
	118	K3	INNENSECHSKANTSCHRAUBE M5X6	
	119	K1	O-RING 74X2,5	
	120	K3	INNENSECHSKANTSCHRAUBE M6X40	
	131	007890 64300	GEWINDEFLANSCH	
	132	K1, K4, K5	DICHTUNG	
	133	K3	INNENSECHSKANTSCHRAUBE M6X16	
	134	K4	SIEB	
	135	948234 00000	SEEGERRING	
	136	K1, K4, K5	O-RING 40X2	
	140	K5	SAUGVENTIL	
	201	002490 64200	ÖLBEHÄLTER A	7)
	201	002490 64300	ÖLBEHÄLTER A	8)
	202	002491 64200	ÖLBEHÄLTER B	7)
	202	002491 64300	ÖLBEHÄLTER B	8)
	203	K1	DICHTUNG	7) 8)
	204	K3	FLACHRUNDKOPFSCHRAUBE M6X20	
	205	003700 64300	WARTUNGSDECKEL	
	206	K3	SECHSKANTSCHRAUBE M6X12	
	207	K1	O-RING 50X2	
	208	K1	DICHTUNG	
	209	K3	STIFTSCHRAUBE M8X20	
	210	K3	SECHSKANTMUTTER M8	
	211	K6	LAGERBOLZEN	
	212	K1, K6	O-RING 4,5X1,8	
	213	K6	DÜSE	
	220	96540064200	LUFTENTÖLELEMENT KOMPLETT	7)
	220	96540064300	LUFTENTÖLELEMENT KOMPLETT	8)
	230	K6	SCHWIMMER	
	232	K1	DICHTELEMENT	
	301	K2	ÖLSCHAUGLAS	
	302	K2	VERSCHLUSSSCHRAUBE G1/2	
	401	951205 00000	VERSCHLUSSSCHRAUBE G1/8	
	402	K1	DICHTRING	
	601	015100 64300	FUSS	
	602	K3	INNENSECHSKANTSCHRAUBE M6X20	
	603	741310 80000	GUMMIPUFFER	
	607	025100 64300	TRANSPORTVORRICHTUNG	
	608	K3	INNENSECHSKANTSCHRAUBE M6X16	

INDEX	Pos.	Bestell Nr.	Beschreibung	
		960017 00025	BECKER LUBE M 32 (MINERALÖL)	0,25 l <sup>9)</sup>
		960003 20025	BECKER LUBE S 32 (SYNTHETIKÖL)	0,25 l <sup>9)</sup>
		960018 00025	BECKER LUBE SL 32 (LEBENSMITTELBEREICH)	0,25 l <sup>9)</sup>
		960023 00300	BECKER LUBE M 68 (MINERALÖL)	1 l <sup>10)</sup>
		960023 00400		5 l
		960023 00500	BECKER LUBE S 68 (SYNTHETIKÖL)	1 l <sup>10)</sup>
		960023 00600		5 l
		960023 00700	BECKER LUBE SL 68 (LEBENSMITTELBEREICH)	1 l <sup>10)</sup>
		960023 00800		5 l
	<sup>1)</sup>	K1 - DICHTUNGSSATZ → POS.: 119, 132,136, 203, 207, 208, 212, 232, 402		
	<sup>2)</sup>	K2 - ÖLSCHAUGLASSSATZ → POS.: 301, 302		
	<sup>3)</sup>	K3 - SCHRAUBENSATZ → POS.: 114, 118, 120, 133, 204, 206, 209, 210, 602, 608		
	<sup>4)</sup>	K4 - SIEBSATZ → POS.: 132, 134, 136		
	<sup>5)</sup>	K5 - SAUGVENTILSATZ → POS.: 132, 136, 140		
	<sup>6)</sup>	K6 - SCHWIMMERVERTILSATZ → POS.: 211, 212, 213, 230		
	<sup>7)</sup>	VERSION - KURZER ÖLBEHÄLTER		
	<sup>8)</sup>	VERSION - LANGER ÖLBEHÄLTER		
	<sup>9)</sup>	FÜR PUMPEN MIT 1~MOTOR		
	<sup>10)</sup>	FÜR PUMPEN MIT 3~MOTOR		

INDEX	Pos.	Ident No.	Description	
	K1	549000 54600	SET OF SEALS	1)
	K2	555300 55500	OIL SIGHT GLASS KIT	2)
	K3	955300 55500	SCREW KIT	3)
	K4	555300 55600	SIEVE KIT	4)
	K5	555300 55700	SUCTION VALVE KIT	5)
	K6	555300 55800	FLOAT VALVE KIT	6)
	111	000110 64100	HOUSING	
	112	020000 64200	ROTOR	
	113	900591 00003	ROTOR VANE KIT	
	114	K3	HEX HEAD SCREW M6X16	
	115	016700 64300	FIXING SLEEVE	
	116	033910 64300	VALVE PLATE	
	117	029110 64300	VALVE KEEPER	
	118	K3	SOCKET HEAD SCREW M5X6	
	119	K1	O-RING SEAL 74X2,5	
	120	K3	SOCKET HEAD SCREW M6X40	
	131	007890 64300	SCREWED FLANGE	
	132	K1, K4, K5	GASKET	
	133	K3	SOCKET HEAD SCREW M6X16	
	134	K4	SIEVE	
	135	948234 00000	SEEGER CIRCLIP	
	136	K1, K4, K5	O-RING SEAL 40X2	
	140	K5	SUCTION VALVE	
	201	002490 64200	OIL TANK A	7)
	201	002490 64300	OIL TANK A	8)
	202	002491 64200	OIL TANK B	7)
	202	002491 64300	OIL TANK B	8)
	203	K1	GASKET	7) 8)
	204	K3	SOCKET HEAD SCREW M6X20	
	205	003700 64300	MAINTENANCE COVER	
	206	K3	HEX HEAD SCREW M6X12	
	207	K1	O-RING SEAL 50X2	
	208	K1	GASKET	
	209	K3	STUD M8X20	
	210	K3	HEX-NUT M8	
	211	K6	BOLT	
	212	K1, K6	O-RING SEAL 4,5X1,8	
	213	K6	NOZZLE	
	220	96540064200	OIL SEPARATING ELEMENT	7)
	220	96540064300	OIL SEPARATING ELEMENT	8)
	230	K6	FLOAT	
	232	K1	SEALING ELEMENT	
	301	K2	OIL SIGHT GLASS	
	302	K2	SCREW PLUG G1/2	
	401	951205 00000	SCREW PLUG G1/8	
	402	K1	SEALING RING	
	601	015100 64300	FOOT	
	602	K3	SOCKET HEAD SCREW M6X20	
	603	741310 80000	BUMPER	
	607	025100 64300	TRANSPORT DEVICE	
	608	K3	SOCKET HEAD SCREW M6X16	

INDEX	Pos.	Ident No.	Description	
		960017 00025	BECKER LUBE M 32 (MINERAL OIL)	0,25 l <sup>9)</sup>
		960003 20025	BECKER LUBE S 32 (SYNTHETIC OIL)	0,25 l <sup>9)</sup>
		960018 00025	BECKER LUBE SL 32 (FOOD SECTOR)	0,25 l <sup>9)</sup>
		960023 00300	BECKER LUBE M 68 (MINERAL OIL)	1 l <sup>10)</sup>
		960023 00400		5 l
		960023 00500	BECKER LUBE S 68 (SYNTHETIC OIL)	1 l <sup>10)</sup>
		960023 00600		5 l
		960023 00700	BECKER LUBE SL 68 (FOOD SECTOR)	1 l <sup>10)</sup>
		960023 00800		5 l
1)		K1 - SET OF SEALS → POS.: 119, 132,136, 203, 207, 208, 212, 232, 402		
2)		K2 - OIL SIGHT GLASS KIT → POS.: 301, 302		
3)		K3 - SCREW KIT → POS.: 114, 118, 120, 133, 204, 206, 209, 210, 602, 608		
4)		K4 - SIEVE KIT → POS.: 132, 134, 136		
5)		K5 - SUCTION VALVE KIT → POS.: 132, 136, 140		
6)		K6 - FLOAT VALVE KIT → POS.: 211, 212, 213, 230		
7)		VERSION - SHORT OIL TANK		
8)		VERSION - LONG OIL TANK		
9)		FOR PUMPS WITH 1~ MOTOR		
10)		FOR PUMPS WITH 3~ MOTOR		



**MAKE IT BECKER**